

**Miele**  
NOVOTRONIC

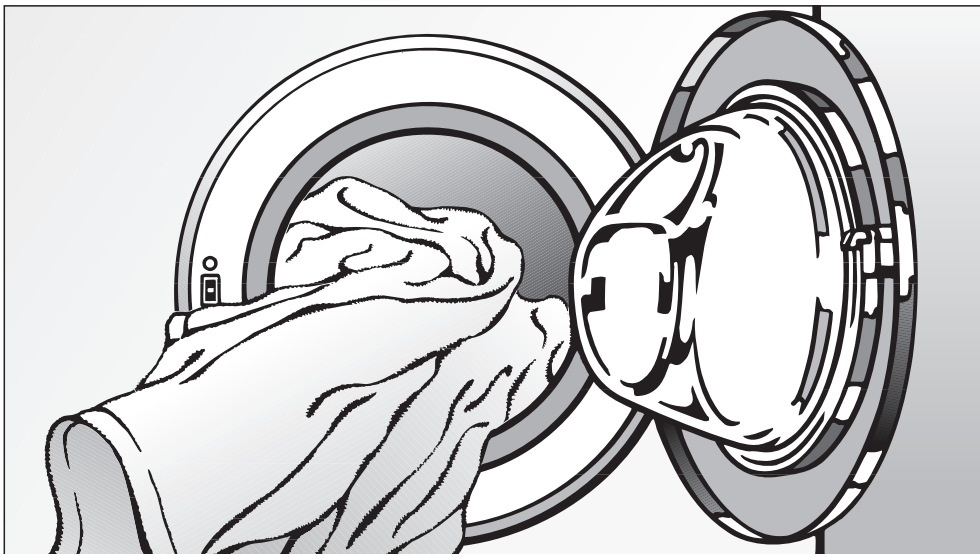

# Operating instructions

## Washer

### W 1986

To prevent accidents and machine damage, read these instructions **before** installation or use.



M.-Nr. 05 665 081

# Contents

---

<b>IMPORTANT SAFETY INSTRUCTIONS</b> . . . . .	4
<b>Guide to the washer</b> . . . . .	5
Control panel . . . . .	5
<b>Before using the washer</b> . . . . .	6
<b>Using the washer</b> . . . . .	7
1. Prepare and sort laundry . . . . .	7
2. Load the laundry . . . . .	8
3. Select a program . . . . .	9
Special programs . . . . .	9
Program guide . . . . .	10
4. Select a spin speed . . . . .	11
5. Select wash options (if needed) . . . . .	12
6. Add detergent . . . . .	13
<b>Detergent</b> . . . . .	14
Water softener . . . . .	14
Fabric softener . . . . .	15
Starch . . . . .	15
Using the "Starch" program . . . . .	15
Fabric dye . . . . .	15
<b>Using the washer</b> . . . . .	16
7. Select Delay Start . . . . .	16
8. Start the program . . . . .	16
9. Activate the program lock (if necessary) . . . . .	16
10. Unload the laundry . . . . .	17
Adding/removing laundry during a wash program . . . . .	18
Cancelling a program that has not yet started . . . . .	18
Cancelling a program that has started . . . . .	19
Making changes to the program . . . . .	19
Skipping part of a program . . . . .	19
To change a program . . . . .	19
<b>Locking the washer</b> . . . . .	20
Electronic program lock . . . . .	20
Child Safety Lock . . . . .	21

<b>Washer care</b> . . . . .	22
Cleaning the washer . . . . .	22
Cleaning the detergent drawer . . . . .	22
Cleaning the drain pump and lint trap . . . . .	23
<b>Quick Guide</b> . . . . .	Center pages
Cleaning the water inlet filters . . . . .	25
Cleaning the inlet hose filter . . . . .	25
Cleaning the filter in the inlet valve . . . . .	25
<b>Frequently asked questions</b> . . . . .	26
The program will not start. . . . .	26
The program stops and a fault indicator blinks. . . . .	26
The program runs normally, but a fault indicator lights up. . . . .	27
Poor wash results. . . . .	28
The door will not open when the "Door" button is pressed. . . . .	30
Opening the drum door during a power failure . . . . .	31
<b>After Sales Service</b> . . . . .	32
<b>Help protect our environment</b> . . . . .	34
<b>Installation</b> . . . . .	35
Front view. . . . .	35
<b>Installation</b> . . . . .	36
Installation site . . . . .	36
Washer / Dryer Stack . . . . .	37
Installation . . . . .	38
Remove the shipping struts . . . . .	38
Level the washer . . . . .	40
Adjust the four leveling feet . . . . .	40
<b>Plumbing connection</b> . . . . .	41
Water connection . . . . .	41
Drainage . . . . .	43
<b>Electrical connection</b> . . . . .	44

# IMPORTANT SAFETY INSTRUCTIONS

---

 **WARNING** - To reduce the risk of fire, electric shock or injury to persons while using your appliance, follow basic safety precautions, including the following:

 Read all instructions before using the appliance.

## **GROUNDING INSTRUCTIONS**

 This appliance must be grounded. In the event of malfunction or breakdown, grounding will reduce the risk of electric shock by providing a path of least resistance for electric current. This appliance is equipped with a cord having an equipment-grounding conductor and a grounding plug. The plug must be plugged into an appropriate outlet that is properly installed and grounded in accordance with all local codes and ordinances.

 **WARNING** - Improper connection of the equipment-grounding conductor can result in a risk of electric shock. Check with a qualified electrician or serviceman if you are in doubt as to whether the appliance is properly grounded.

 Do not modify the plug provided with the appliance - if it will not fit the outlet, have a proper outlet installed by a qualified electrician.

 Do not allow children to play on or in the appliance. Close supervision is necessary when the appliance is used near children.

 Do not wash articles that have been previously cleaned in, washed in, soaked in or spotted with gasoline, dry-cleaning solvents or other flammable or explosive substances. These articles give off vapors that could ignite or explode. Do not add these items to the washload.

 Under certain conditions, hydrogen gas may be produced in a hot water system that has not been used for 2 weeks or more. **HYDROGEN GAS IS EXPLOSIVE.** If the hot water system has not been used for such a period, turn on all hot water faucets and let the water flow from each for several minutes before using the washing machine. This will release any built up hydrogen gas. Do not smoke or use an open flame during this time, as the gas is flammable .

 Before the appliance is removed from service or discarded, remove the door.

 Do not reach into the appliance if the drum is moving.

 Do not install or store this appliance where it will be exposed to the weather.

 Do not tamper with the controls.

 Do not repair or replace any part of the appliance or attempt any servicing unless specifically recommended in these operating instructions.

**SAVE THESE INSTRUCTIONS**

## Control panel

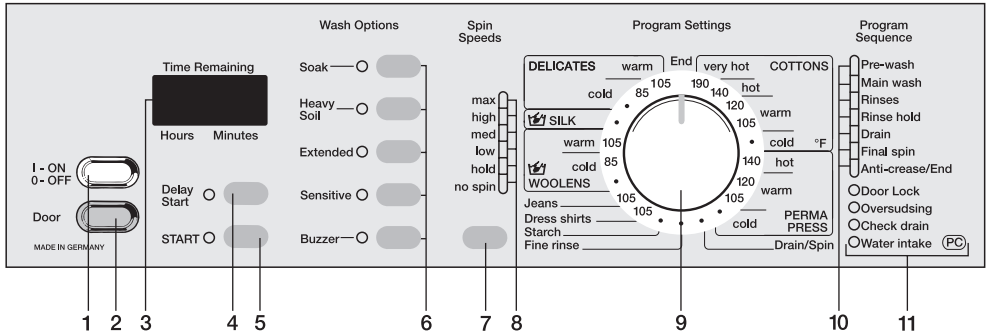

### 1 "On/Off" button

Turns the machine on and off or interrupts a program.

### 2 "Door" button

Opens the drum door.

### 3 "Time Remaining" display

Shows the countdown to the end of the program.

### 4 "Delay Start" button

Allows you to delay the start of a program from 30 minutes to 24 hours. This time will appear in the "Time Remaining" display.

### 5 "START" button

Begins the wash program.

### 6 Wash options

Special wash features available to enhance a wash program.

### 7 Spin speed selector button

Allows you to select the final spin speed of a program.

### 8 Spin speed indicator light

Indicates the current spin speed.

### 9 Program selector

For selecting a program and wash temperature. The light ring will go out a few minutes after the end of the program to save energy.

### 10 Program sequence display

Shows the current cycle of the wash program.

### 11 Fault indicators

Indicate when a fault has occurred.

## Before using the washer

---

The appliance must be correctly installed and connected before the first use. Please see the "Installation instructions."

Before using the washer, a program must be run without laundry and without detergent to flush out any residual water from the factory testing process.

- Close the washer door.
- Press the "On/Off" button.
- Turn the program selector to "COTTONS/very hot".
- Press the "Spin" button until the "high" mark of the indicator lights.
- Press the "START" button.

Once the program ends, the washer can be used for laundry.

## 1. Prepare and sort laundry

- Empty all pockets.

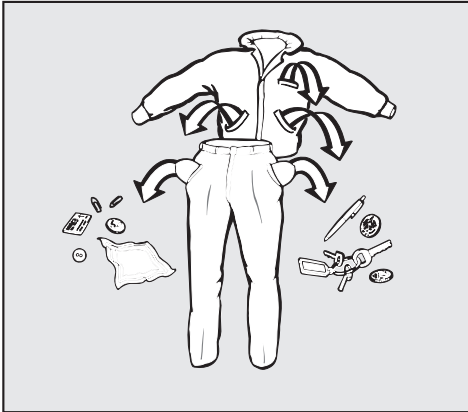

 Foreign objects left in pockets (e.g. nails, coins, paper clips, etc.) can cause damage to clothes and the machine.

- Sort the laundry.

Only wash items that are labeled machine washable by the manufacturer. Most garments have a fabric care label in the collar or side seam. Sort the laundry by care label and color.

- Pretreat stains.

Tough stains (blood, egg, coffee, tea, etc.) or badly soiled areas (collars and cuffs) should be pretreated with a stain remover or a paste made from powdered detergent and warm water.

- Dark fabrics often bleed the first few times they are washed. They should be washed separately several times before being included in a mixed load.
- Remove any lead weights or strips from curtains before washing.
- Loose undergarment underwires should be removed or sewn in place before washing.
- Woolens and knitted garments should be turned inside out.
- Close zippers, hooks and eyelets before washing.

# Using the washer

---

## 2. Load the laundry

- Turn on the washer using the "On/Off" button.
- Open the drum door using the "Door" button.
- Load the laundry into the drum.  
For best results, wash mixed loads of small and large items. This will improve washing effectiveness and help distribute the load evenly.

Note: Overloading the washer will cause poor wash results and wrinkling.

- Close the drum door.

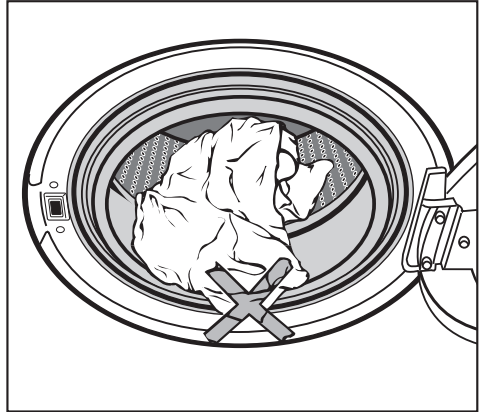

To prevent damage to the door seal and clothing, make sure that there are no clothes caught between the drum door and the seal.



## 3. Select a program

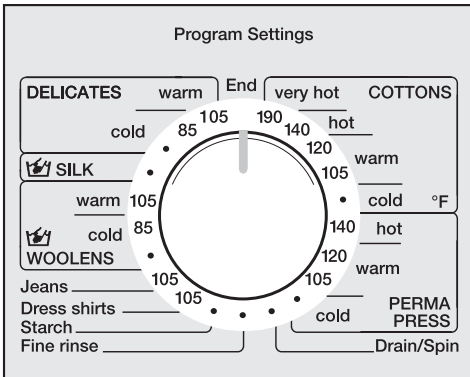

- Turn the program selector in either direction to the program you wish to use.

## Special programs

### SILK

Gentle program for hand and machine washable silk fabrics. Cool water and slower wash, rinse and spin cycles reduce wrinkling and fading.

### WOOLENS

Specialty care program for hand and machine washable wool and wool blends. A mild range of wash temperatures, low water level and minimum drum movement gently clean and maintain the shape of garments.

### Jeans

Specially designed program that washes denim materials at the correct temperature and spin speed to release stains and prevent wrinkles.

### Dress shirts

Program for cleaning dress shirts with reduced wrinkling.

### Fine rinse































Laundry is rinsed and spun only.

### Starch

This program is for starching without washing. See "Detergent/ Using the "Starch" program" for details.

# Using the washer

## Program guide

Temperature	Care symbols	Fabric		
<b>Cottons</b> Available wash options: Soak, Heavy soil, Extended, Sensitive				
190 °F / very hot		–	white household linens	100 % cotton sheets, cloth diapers, towels, etc. to be sanitized. Not for use with clothing with elastic.
140 °F / hot		–	sturdy white cottons	Underwear, cotton t-shirts, socks.
120 °F / warm			light colors	Colorfast items.
105 °F / warm			bright colors	
● / cold			dark colors	Black items, mixed loads.
<b>PERMA PRESS</b> Available wash options: Soak, Heavy soil, Extended, Sensitive				
140 °F / hot		–	whites	For cotton blends, polyester blends and synthetics (e.g. acrylic, nylon, ramie). Fabric softener can be dispensed in the final rinse of these programs to reduce static cling.
120 °F / warm			light colors	
105 °F / warm			bright colors	
● / cold			dark colors & temperature sensitive fabrics	Spandex, microfibers, etc.
<b>Drain / Spin</b> No available wash options				
<b>DELICATES</b> Available wash options: Soak, Heavy soil, Extended				
105 °F / warm			light colors	For synthetics, machine washable silks, satin, hosiery, lingerie, lace or crocheted (non-wool) items; curtains and knits.
85 °F / cold			dark colors	
● / cold		–	lace or sheer fabrics, embroidered items.	
<b>SILK</b> No available wash options				
● / cold			silks and silk blends, lingerie and hosiery	Ideal for machine and hand washable silks and other non-wool handwashable garments.
<b>WOOLENS</b> No available wash options				
105 °F / warm			light colors	For hand washable and machine washable wool and wool blends (e.g. lamb's wool, cashmere, mohair, angora, etc.)
85 °F / cold			dark colors	
● / cold	–	–	delicate woollens	
<b>Jeans</b> No available wash options				
105 °F			denim	
<b>Dress shirts</b> Available wash options: Soak, Heavy soil, Extended				
105 °F				
<b>Starch</b> No available wash options				
<b>Fine rinse</b> No available wash options				

## 4. Select a spin speed

The default spin speed will automatically be selected for each program. However, you can adjust the spin speed within the parameters listed below:

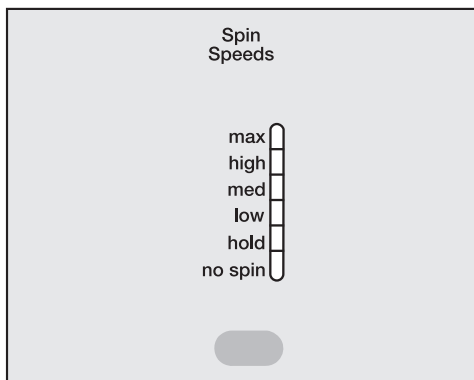

- Press the button until the indicator for the desired spin speed lights.

## Special spin options

- Hold

Laundry is not spun and remains soaking in water. This will prevent wrinkles if the laundry is not removed immediately at the end of the wash program. When ready, select a spin speed to continue the program. To finish the program, press the "Door" button.

- No spin

The laundry is not spun after the final rinse, but the water is drained away. After the drain cycle the washer goes immediately into the anti-crease cycle. Spinning between the rinses is also omitted in this setting.

This option is not available in the "COTTONS" program.

Available spin speeds	Program
max to high	COTTONS
max to no spin	WOOLENS, Jeans, Starch, Fine rinse, Drain/Spin
high to no spin	PERMA PRESS, Dress shirts
med to no spin	DELICATES
low to no spin	Silk

# Using the washer

---

## 5. Select wash options (if needed)



- Press the button for the wash options you would like to select. The indicator light for the respective option will illuminate.

If a wash option is chosen and it is not compatible with the program, the indicator light will go out when the button is released.

### Soak

For heavy soiling and stubborn stains (e.g. blood, grease, cocoa) that require soaking before the main wash.

Each press of the "Soak" button will add 30 minutes (6 hours maximum) of soak time to the wash program.

### Heavy soil

For heavily soiled laundry where a pretreatment is necessary to remove surface soiling.

### Extended

For laundry with stubborn or old stains. The longer wash time works to relax fabrics and release stains.

The total time for the wash program will be extended.

### Sensitive

An additional final rinse will wash away detergent residue and scents.

### Buzzer

A buzzer can be selected to signal the end of the wash program.

The buzzer will sound until the washer is turned off.

## 6. Add detergent

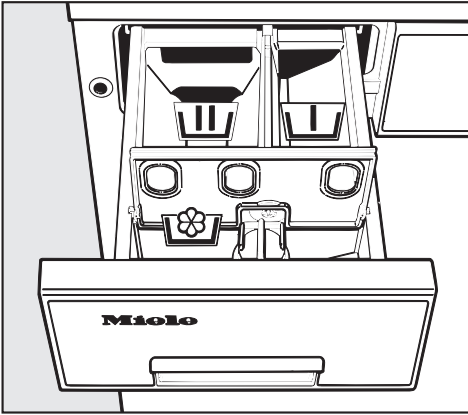

- Pull out the detergent dispenser drawer and add detergent to the appropriate compartments.

 = Detergent for the main wash

 = Only add detergent ( $\frac{1}{4}$  of the total recommended amount of detergent) to this compartment if the "Heavy Soil" wash option is selected.

 = Fabric softener or liquid starch.

- Close the detergent dispenser drawer.

 Do not use detergents containing chemical solvents.

# Detergent

---

Use only high-efficiency, low sudsing laundry detergent formulated for front loading washing machines.

For wool and wool blend fabrics, use a detergent formulated for wools.

Follow instructions on the detergent packaging for the correct use and amount of detergent. You may need to adjust the amount of detergent if the load is smaller or more or less soiled than normal.

Add detergent to compartment **W** at the beginning of each wash program. Only add detergent ( $\frac{1}{4}$  total recommended amount) to compartment **V** if the "Heavy soil" option was selected.

If you select the "Heavy soil" option and you are using liquid detergent, insert the liquid detergent insert into compartment **W**. This will prevent the detergent for the main wash being used in the first wash of the "Heavy soil" option.

**Do not use chlorine bleach!**

## Water softener

If your water hardness level is between 2 and 3, the water can be softened to reduce detergent consumption.

Use the recommended amount of detergent for water hardness level 1, and then add a water softener to the detergent dispenser.

## Water hardness

Hardness level	Water quality	Water hardness ppm
1	soft	0 - 130
2	middle	130 - 250
3	hard to very hard	over 250

## Fabric softener

Fabric softener added to the wash program will make fabrics feel softer and will reduce static cling in the dryer.

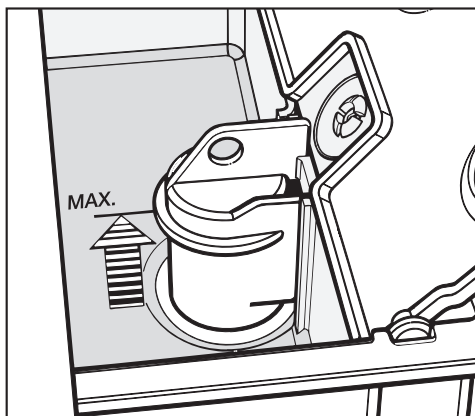

- Open the lid of the fabric softener compartment ☼.
- Pour the amount of liquid fabric softener into the compartment according to the manufacturer's instructions. Do not exceed the maximum fill level marked inside the compartment, as the excess will prematurely activate the siphon and be wasted.
- Close the compartment lid and push in the dispenser drawer.

The softener will automatically be dispensed during the final rinse cycle. A small amount of water will remain in the compartment at the end of the program.

Never mix fabric softener and starch together in the fabric softener. This will clog the dispenser.

## Starch

Starching can be included in any wash program as part of the final rinse, or can be performed separately:

- Open the fabric softener compartment ☼.
- Add the recommended amount of starch.
- Close the compartment lid and push in the dispenser drawer.
- The starch will be dispensed during the final rinse.

## Using the "Starch" program

- Add the amount of starch recommended on the packaging to the fabric softener compartment ☼.
- Turn the program selector to "Starch".
- Select a spin speed.
- Press the "START" button.

If starch is used frequently, clean the dispenser compartment, especially the siphon tube and fabric softener duct. See "Cleaning the detergent dispenser drawer".

## Fabric dye

- Do not use fabric dyes in this washer.

# Using the washer

---

## 7. Select Delay Start

If you wish, the start of the wash program can be delayed to take advantage of lower energy rates, or to have a load completed at a later time.



- Press the "Delay Start" button until the desired time delay appears in the "Time Remaining" display.

The time will appear:

- in 30 minute increments for times less than 10 hours.
- in 1 hour increments for times greater than 10 hours.

### Cancelling Delay Start

- Press the Delay Start button until *24 h* appears in the display.

## 8. Start the program

Press "START" to begin the program. The maximum program run time will appear in the display.

## 9. Activate the program lock (if necessary)

- Press the "START" button until the "Door Lock" indicator lights up.

See "Locking the washer" for further details.



## 10. Unload the laundry

- Open the drum door by pressing the "Door" button.

Do not attempt to remove laundry from the washer if the drum is turning. You may seriously injure yourself. If the drum turns with the door open, contact Miele's Technical Service Department.

- Remove the laundry.

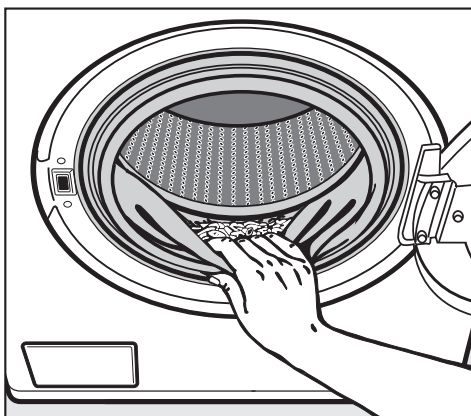

- Check the folds of the door seal for any small articles which may have been trapped.

Check the drum for any missed pieces of laundry. Items inadvertently left in the washer may be damaged (e.g. shrink or discolor) during the next wash cycle.

- Turn off the washer using the "On/Off" button and turn the program selector to "End".
- Close the drum door.

# Using the washer

---

## Adding/removing laundry during a wash program

You can interrupt the following programs to add or remove a piece of laundry:

- COTTONS
- PERMA PRESS
- Jeans
- Dress Shirts
- Starch
- Press the "Door" button and open the drum door.
- Add or remove the piece of laundry.
- Close the door.

The program will automatically continue.

### **The drum door cannot be opened if:**

- the water temperature is greater than 130°F.
- the water level is too high.
- the electronic program lock is activated.
- the program has reached the final spin cycle.

If you press the "Door" button during any of these conditions, the "Door Lock" indicator will light.

## Cancelling a program that has not yet started

- Turn the program selector to "End".
- Once the "Time remaining" display goes blank, turn the program selector to the new program.

## Cancelling a program that has started

- Turn off the washer with the "On/Off" button.
- Turn the program selector to "End".
- Turn on the washer with the "On/Off" button.
- Turn the program selector to "Drain/Spin".
- Select the desired spin speed.
- Press "Start".

## Making changes to the program

The following changes can be made to a program once it has already started:

- the spin speed may always be adjusted.
- the wash options "Sensitive" and "Extended" can be selected or deselected up to 6 minutes after the start of a program , and the temperature of the program can be changed to another temperature within the same program.

Once the program starts, you cannot change to a different program.

The "Anti-crease/End" indicator will blink if the program selector has been moved. The program will not be affected. The indicator will go out if the program selector is turned back to the original program.

## Skipping part of a program

- Turn the program selector to "End".

When the desired program cycle flashes in the program sequence display:

- Turn the program selector back to the original program within 4 seconds .

## To change a program

- Turn off the washer using the "On/Off" button.
- Turn the program selector to "End".
- Turn on the washer using the "On/Off" button.
- Select the new program.
- Select the desired spin speed.
- Press the "START" button.

# Locking the washer

---

## Electronic program lock

The program lock prevents the washer from being opened or the program from being changed during a wash program.

### To activate the program lock

- Once the wash program has started, hold the "START" button until the "Door Lock" indicator illuminates.

The program lock is now activated.

The washer can no longer accept program changes and will continue to the end of the program.

At the end of the program, the lock is automatically unlocked.

## To cancel the program lock

- Hold the "START" button until the "Door Lock" indicator goes out.

Exception:

The program selector was moved and the "Anti-crease/End" indicator blinks in the program sequence display.

- Turn the program selector back to the originally selected program. The "Anti-crease/End" indicator light goes out.
- Press the "START" button until the "Door Lock" indicator goes out.

## Child Safety Lock

This safety lock can be activated to prevent a child from climbing inside the washer.

When the child safety lock is activated, the drum door cannot be opened and a program cannot be started.

### To activate the safety lock

Before activating the lock:

- the drum door must be closed,
- the program selector must be at "End".

- 1.** Turn on the washer using the "On/Off" button.
- 2.** Press the "Heavy Soil" button and hold the button pressed in during steps **3.** to **5.**
- 3.** Turn the program selector slowly in a clockwise motion to "COTTONS/ 140 °F".
- 4.** Turn the program selector slowly in a counterclockwise motion to "End".

- 5.** Turn the program selector slowly in a counterclockwise motion to the "DELICATES/cold" position.

The "Door Lock" indicator (lower right of control panel) flashes.

- 6.** Release the "Heavy Soil" button.
- 7.** Turn the program selector to "End".
- 8.** Turn off the washer using the "On/Off" button.

### To deactivate the safety lock

Repeat steps **1.** through **6.** The "Door Lock" indicator goes out.

## Washer care

 Before cleaning the appliance, disconnect the power supply by unplugging the unit or manually tripping the circuit breaker.

### Cleaning the washer

- Clean the exterior of the washer with a mild solution of non-abrasive detergent or soap and water. Wipe dry with a soft cloth.
- Clean the drum with a stainless steel cleaner specially formulated for use in a washer. This type of cleaner is available from Miele's Technical Service Department: (part # 00 077 927)

### Cleaning the detergent drawer

Detergent residue should be cleaned regularly.

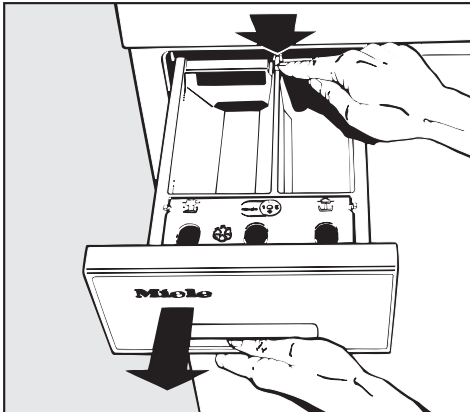

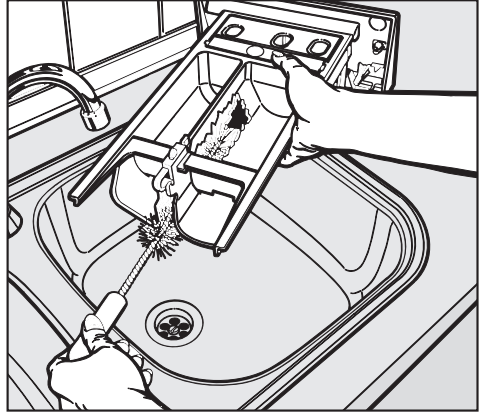

- Pull out the detergent drawer until it stops. Press the red release lever down and pull the drawer out of the machine.

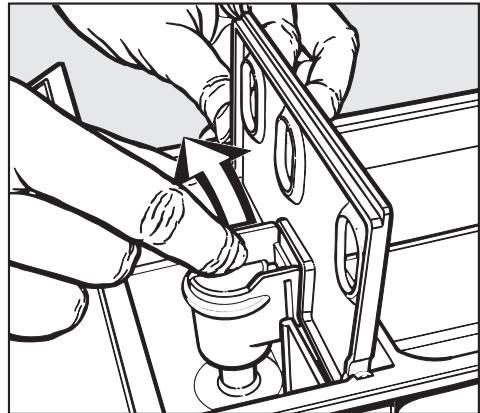

- Clean the dispenser compartments and the fabric softener duct.



- Remove the siphon tube from the fabric softener compartment  and rinse under warm water.

 Do not use chemical solvents, abrasive cleaners, glass or all purpose cleaners. These can damage plastic surfaces and other parts. Do not use a hose to clean the washer.

## Cleaning the drain pump and lint trap

Occasionally, small objects (buttons, coins, etc.) may become trapped in the lint trap. If the machine does not drain completely, the lint trap should be checked to ensure that it is free of foreign objects.

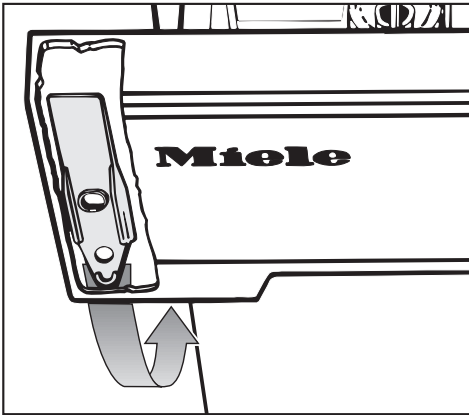

- To clean the lint trap, remove the tool from behind the detergent dispenser drawer.

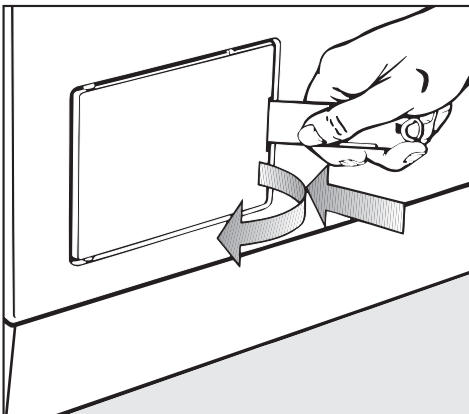

- Open the lint trap door.

- Place a 2 quart capacity container underneath the drain tube.

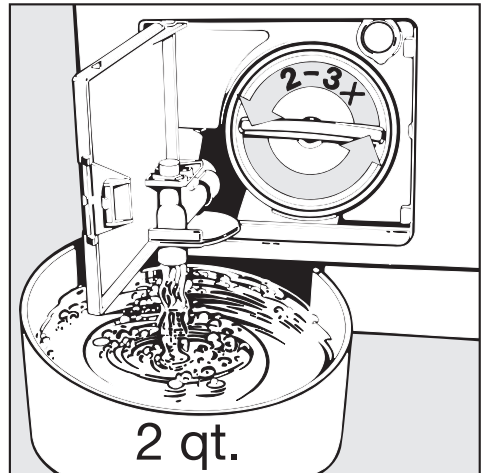

- Turn the lint trap lid counterclockwise 2 - 3 times. Do **not** remove it. About 2 quarts of water will drain out of the hose.

If the main drain hose is clogged, additional water will remain in the machine. In this case, tighten the lint trap lid and empty the container.

**⚠ Caution:** If the laundry has been washed at a high temperature, the water draining out of the machine will still be hot. Allow it to cool before proceeding.

# Washer Care

Once the flow of water stops:

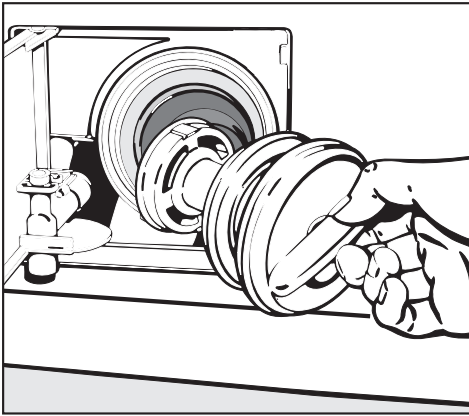

- Remove the lint trap lid.
- Clean out any foreign objects or lint from the filter.
- Check that the drain pump impeller (in the back of the chamber) rotates freely by spinning with your hand.

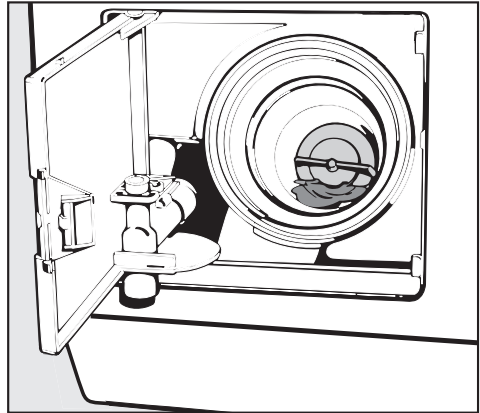

- Clean the inside of the lint trap housing. Remove any detergent deposits or foreign objects from the threads of the filter housing and filter unit before returning the lint trap.
- Return the lint trap and tighten into place.

 If the lint trap is not tightened securely, water will leak out when the machine is in use.

## After cleaning:

- Run the "Fine rinse" program.

This step is necessary to activate the ball valve.



## Quick Guide

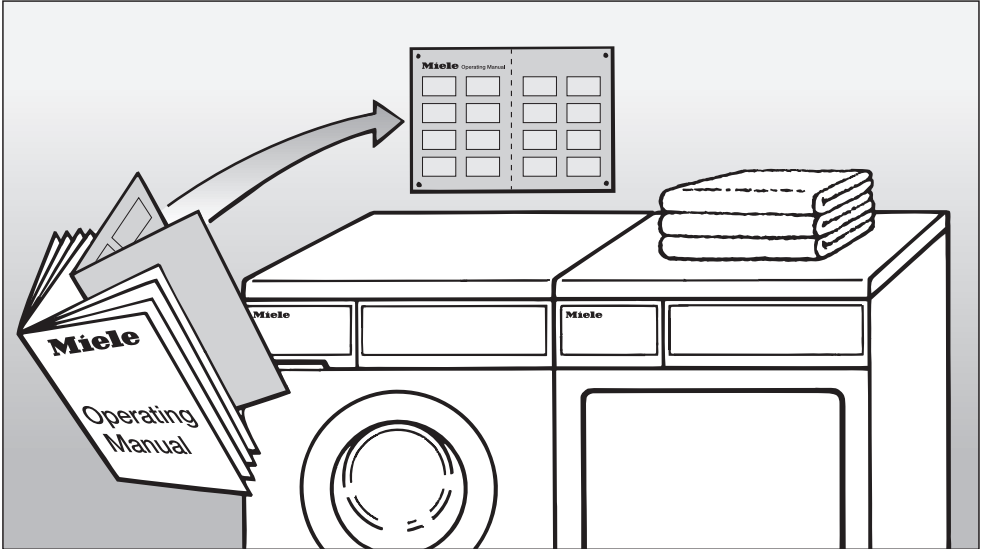

Remove this guide for easy reference

Please read all instructions, especially the "Important Safety Instructions", **before** using the washer.

# Quick Guide

## 1. Prepare and sort laundry

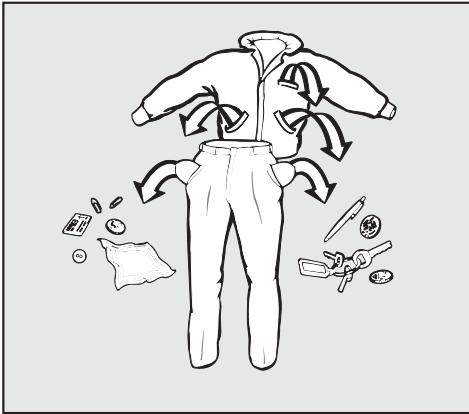

- Empty pockets.
- Sort laundry by fabric and color.
- Pretreat stains.

## 2. Load the laundry



- Turn on the washer using the "On/Off" button.



- Open the drum door using the "Door" button.
- Load the laundry.
- Close the drum door.  
Make sure clothes will not be caught by the door.

## 3. Select a program

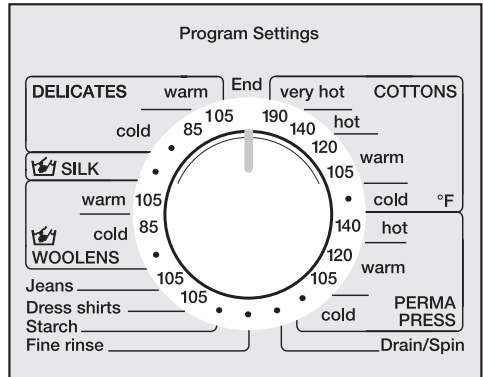

- Turn the program selector in either direction to the desired program.

Check the "Program guide", to determine which program is most appropriate for the load being washed.

## 4. Select the spin speed

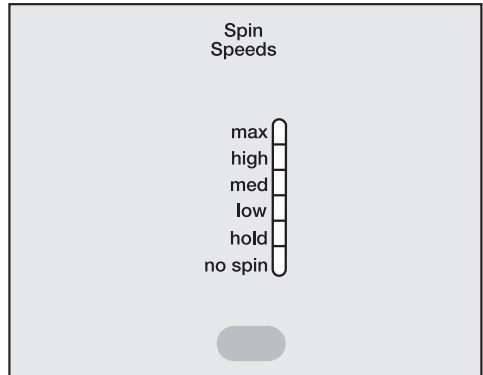





- Load the laundry.
- Close the drum door.  
Make sure clothes will not be caught by the door.

## 5. Select wash options (if needed)

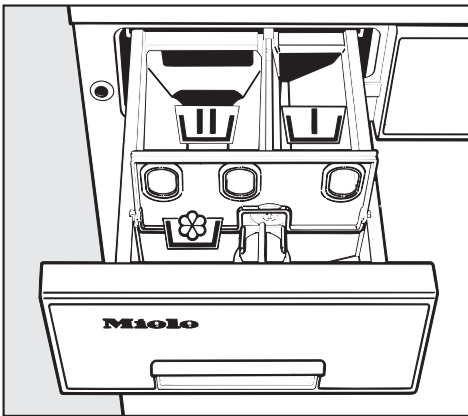

## 6. Add detergent



-  = Detergent compartment for the main wash
-  = Only add detergent ( $\frac{1}{4}$  of the total recommended amount of detergent) to this compartment if the "Heavy Soil" wash option is selected.
-  = Fabric softener or liquid starch

## 7. Select Delay Start (if needed)



## 8. Start the program



- Press "START".

## 9. Activate the program lock (if necessary)



- Hold the "START" button until the "Door Lock" indicator lights up.































## 10. Unload the laundry

- Open the drum door using the "Door" button
- Remove the laundry.



- Turn off the washer using the "On/Off" button and turn the program selector to "End".
- Close the drum door.

# Quick Guide

Temperature	Care symbols		Fabric	
<b>Cottons</b> Available wash options: Soak, Heavy soil, Extended, Sensitive				
190 °F / very hot		–	white household linens	100 % cotton sheets, cloth diapers, towels, etc. to be sanitized. Not suitable for clothing containing elastic.
140 °F / hot		–	sturdy white cottons	Underwear, cotton t-shirts, socks.
120 °F / warm			light colors	Colorfast items.
105 °F / warm			bright colors	
● / cold			dark colors	Black items, mixed loads.
<b>PERMA PRESS</b> Available wash options: Soak, Heavy soil, Extended, Sensitive				
140 °F / hot		–	whites	For cotton blends, polyester blends and synthetics (e.g. acrylic, nylon and ramie). Fabric softener can be dispensed in the final rinse of these programs to reduce static cling.
120 °F / warm			light colors	
105 °F / warm			bright colors	
● / cold			dark colors & temperature sensitive fabrics	Spandex, microfibers etc.
<b>Drain / Spin</b> No available wash options				
<b>DELICATES</b> Available wash options: Soak, Heavy soil, Extended				
105 °F / warm			light colors	For synthetics, machine washable silks, satin, hosiery, lingerie, lace or crocheted (non-wool) items; curtains and knits.
85 °F / cold			dark colors	
● / cold		–	lace or sheer fabrics, embroidered items.	
<b>SILK</b> No available wash options				
● / cold			silk and silk blends, lingerie and hosiery	Ideal for machine and hand washable silks and other non-wool handwashable garments
<b>WOOLENS</b> No available wash options				
105 °F / warm			light colors	For hand washable and machine washable wool and wool blends (e.g. lamb's wool, cashmere, mohair, angora etc.)
85 °F / cold			dark colors	
● / cold	–	–	delicate woolens	
<b>Jeans</b> No available wash options				
105 °F			denim	
<b>Dress shirts</b> Available wash options: Soak, Heavy soil, Extended				
105 °F				
<b>Starch</b> No available wash options				
<b>Fine rinse</b> No available wash options				

## Cleaning the water inlet filters

The washer has two water inlet filters to protect each inlet valve. These filters should be checked every 6 months and cleaned, if necessary. (This may need to be performed more frequently with some water supplies).

## Cleaning the inlet hose filter

- Turn off the water valve.
- Unscrew the inlet hose from the valve by turning the connector counterclockwise using a wrench, if necessary.

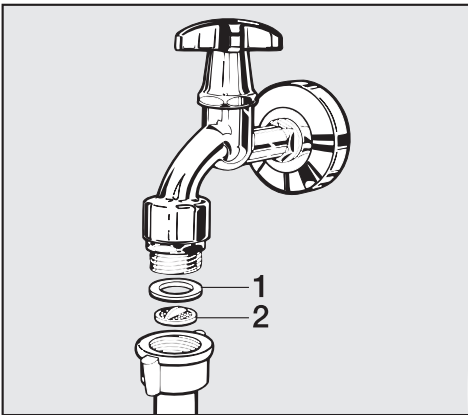

- Remove the rubber seal, **1**, from the connector.
- Using needle nose pliers, grasp the plastic filter, **2**, and pull it out of the hose connector.
- Clean the filter under running water and carefully remove any large particles. Replace the filter and seal and reconnect the hose.
- Slowly turn on the valve and check for leaks.

 Inspect the hose regularly. The hose must be in good condition to withstand high water pressure. The hose should be replaced if there are cracks in the surface, or if it has been otherwise damaged or cut.

## Cleaning the filter in the inlet valve

- Using a wrench, carefully loosen and remove the plastic hose connector on the inlet valve.

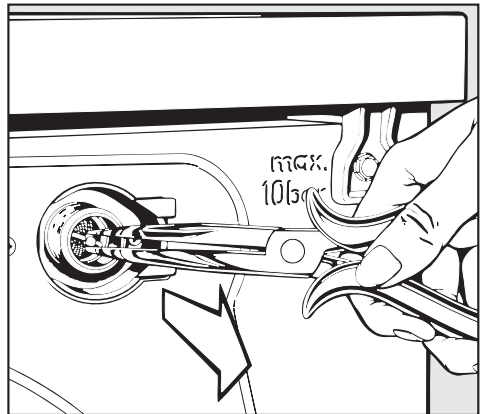

- Using needle nose pliers, remove the plastic filter by pulling on the bar (see illustration). Rinse under water and return parts.

Both filters **must** be put back in place after cleaning.

## Frequently asked questions

With the following guide, minor issues can be resolved without a service call:

<b>The program will not start.</b>		
<b>Issue</b>	<b>Possible cause</b>	<b>Solution*</b>
<b>The "Anti-crease/End" indicator does not light, or the "START" button does not blink.</b>	The washer has no power.	Check to determine: <ul style="list-style-type: none"> <li>– if the unit is plugged in.</li> <li>– if the circuit breaker has tripped.</li> </ul>
<b>The "Door Lock" indicator blinks.</b>	The lock function is activated.	Deactivate the lock function.
<b>The program stops and a fault indicator blinks.</b>		
<b>Issue</b>	<b>Possible cause</b>	<b>Solution*</b>
<b>The buzzer sounds and "Check drain" blinks. "- - -". appears in the display.</b>	The drain is blocked.	Clean the drain filter and the drain pump.
	The drain hose is too high.	The maximum drain pump height should not exceed 4 feet.
<b>The buzzer sounds and "Water intake" blinks. "- - -". appears in the display.</b>	The water inlet is blocked.	Open the water valve.
<b>The buzzer sounds, and either the "Pre-wash" or "Rinses" indicators of the sequence display blink. "- - -". appears in the display.</b>	There is a fault.	Restart the program. If the fault message appears again, call Miele's Technical Service Department.

\* To turn off the fault indicator light: Turn off the washer with the "On/Off" button and turn the program selector to "End".

## Frequently asked questions

<b>The program runs normally, but a fault indicator lights up.</b>		
<b>Issue</b>	<b>Possible cause</b>	<b>Solution *</b>
<b>The "Check drain" indicator blinks.</b>	The drain is blocked.	Clean the lint trap and the drain pump.
<b>The "Water intake" indicator blinks.</b>	The water intake is impaired.	Check to determine: <ul style="list-style-type: none"> <li>– if the water valve is open.</li> <li>– if the inlet hose is kinked.</li> </ul>
	The inlet hose filter is dirty.	Clean the filter under running water and carefully remove any large particles.
<b>The "Oversudsing" indicator lights.</b>	The machine has oversudsed.	Run a drain cycle. Only use the recommended amount of a high-efficiency detergent.
<b>The "Main Wash" indicator blinks in the program sequence display.</b>	There is a fault.	Restart the program. If the fault message appears again, call Miele's Technical Service Department.
<b>The "Anti-crease/End" indicator blinks in the program sequence display.</b>	The program selector was moved to a different setting after the program started.	Turn the program selector to the original position.

\* To turn off the fault indicator light: Turn off the washer with the "On/Off" button and turn the program selector to "End".

## Frequently asked questions

<b>Poor wash results.</b>		
<b>Issue</b>	<b>Possible cause</b>	<b>Solution</b>
<b>The washer shakes during the spin cycle.</b>	The washer's feet are not resting evenly on the floor.	Level the machine (see Installation Instructions).
	The shipping struts have not been removed.	Remove the shipping struts.
<b>The wash is too wet after the final spin.</b>	The spin speed was too low.	Select a higher spin speed for future loads.
<b>There are unusual sounds coming from the drain pump.</b>	There is no fault.	Lapping sounds at the beginning and end of the pump process are normal.
<b>The light ring does not light.</b>	The washer has turned off the light ring to conserve energy.	To turn the light ring back on, press a wash option button or turn the program selector.
<b>Detergent residue remains in the dispenser drawer.</b>	The water pressure is too low.	<ul style="list-style-type: none"> <li>– Clean the water intake hose filter under running water and carefully remove any large particles.</li> <li>– Select the "Sensitive" wash option for future loads.</li> </ul>
	Detergent used with a water softener tends to become sticky.	Add detergent to the dispenser before adding a water softener.
<b>The fabric softener is not completely dispensed, or too much water remains in the fabric softener compartment.</b>	The siphon tube is clogged or positioned incorrectly.	Clean the siphon tube (see "Washer care / Cleaning the detergent dispenser drawer").
	The dispenser drawer was not pushed in when the fabric softener was being dispensed.	Make sure the dispenser drawer is pushed in completely.



## Frequently asked questions

Issue	Possible cause	Solution
<b>The laundry has a gray, sticky residue</b>	An inadequate amount of detergent was used to dissolve greasy deposits in heavily soiled laundry.	<ul style="list-style-type: none"><li>– Add more detergent.</li><li>– Before washing the next load, run an empty load on "COTTONS/140°F" with detergent to clean out the machine.</li></ul>
<b>There is white detergent residue on dark laundry.</b>	The detergent was not completely dissolved due to hard water.	<ul style="list-style-type: none"><li>– Before drying, remove white residue with a clothing brush.</li><li>– Add water softener to future loads.</li></ul>

## Frequently asked questions

**The door will not open when the "Door" button is pressed.**

<b>Issue</b>	<b>Solution</b>
<b>The washer is not hooked up to electricity.</b>	Insert the plug into the outlet.
<b>The washer is not turned on.</b>	Turn on the washer using the "On/Off" button.
<b>The Child Safety Lock is activated.</b>	Deactivate the Child Safety Lock (see "Locking the washer").
<b>The electronic lock function is activated.</b>	Deactivate the electronic safety lock. (see "Locking the washer").
<b>The door was not closed correctly.</b>	Push on the drum door and at the same time, press the "Door" button.
<b>There is still water in the drum and the washer cannot drain it out.</b>	Clean the lint trap and the drain pump (see "Washer care").
<b>The "hold" spin speed was selected.</b>	Select a spin speed to continue the program. Once the program ends, you will be able to open the door.
<b>The "no spin" speed was selected.</b>	Turn the program selector to "Drain/Spin". Select a spin speed and press "START". Once the program ends, you will be able to open the door.
As a safeguard against scalding, the drum door cannot be opened if the wash water temperature is over 130°F.	

### Opening the drum door during a power failure

- Open the detergent dispenser drawer.

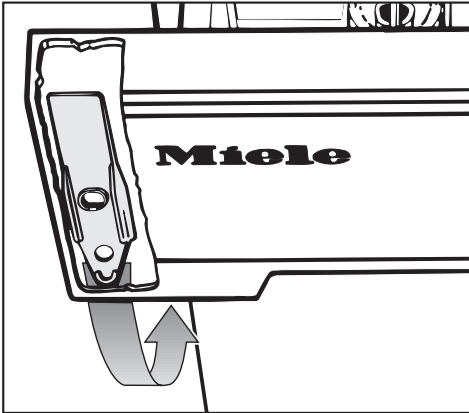

- Remove the tool.

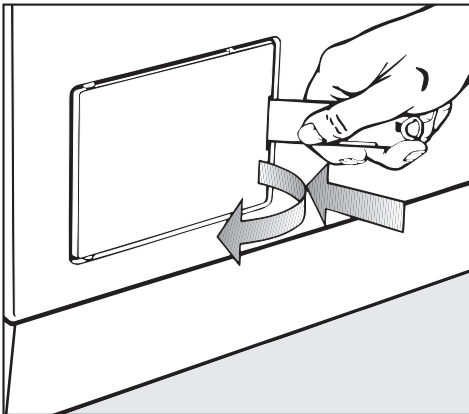

- Open the lint trap door.
- Drain the water from the washer (see "Washer care / "Cleaning the drain pump and lint trap").

⚠ Make sure the machine is off and the drum has stopped turning. A moving drum is dangerous.

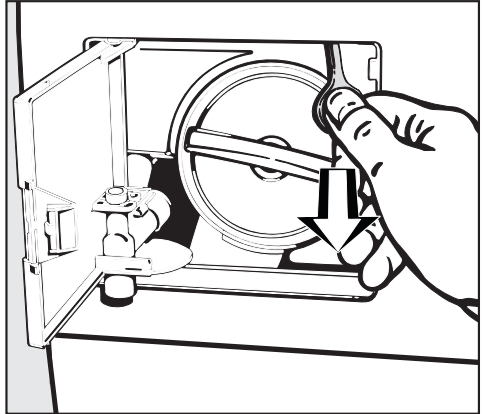

- To open the door, pull down on the ring in the upper right corner of the access area.

# After Sales Service

---

In the event of any fault which you cannot fix yourself, please contact the Miele Technical Service Department

**USA** 1-800-999-1360  
techserv@mieleusa.com

**CDN** 1-800-565-6435  
service@miele.ca

When contacting the Technical Service Department, please quote the model and serial number of your appliance. Both can be found on the data plate visible above the glass on the inside of the door.

## PC Update

The indicator marked PC allows a service technician to update your machine's wash programs if new programs are developed or new fabrics are introduced.

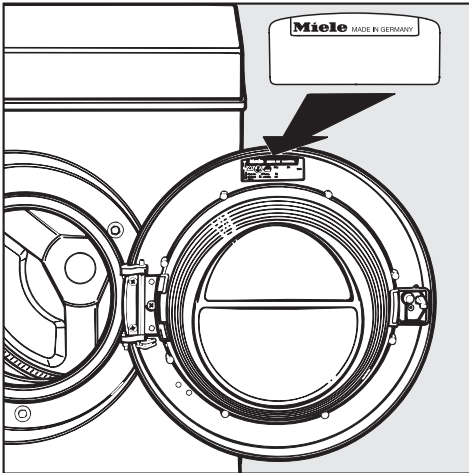

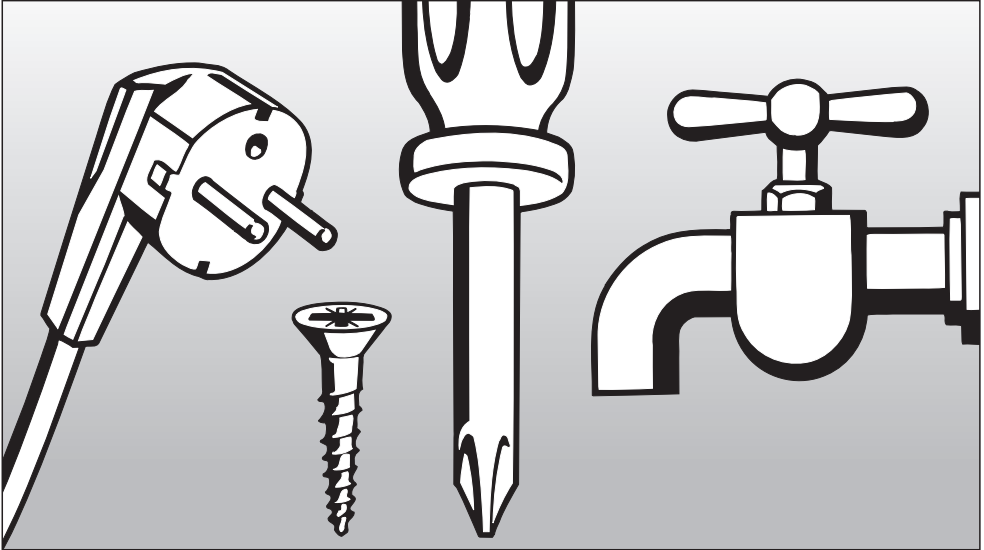

## INSTALLATION INSTRUCTIONS

# Help protect our environment

---

## **Disposal of the packing material**

The cardboard box and packing materials protect the appliance during shipping. They have been designed to be biodegradable and recyclable.

Ensure that any plastic wrappings, bags, etc. are disposed of safely and kept out of the reach of children, as they pose a danger of suffocation.

## **Disposal of an appliance**

Old appliances may contain materials that can be recycled. Please contact your local recycling authority about the possibility of recycling these materials.

Ensure that the appliance presents no danger to children while being stored for disposal. Before discarding an appliance, unplug it from the outlet, cut off its power cord and remove any doors to prevent hazards.

## Front view

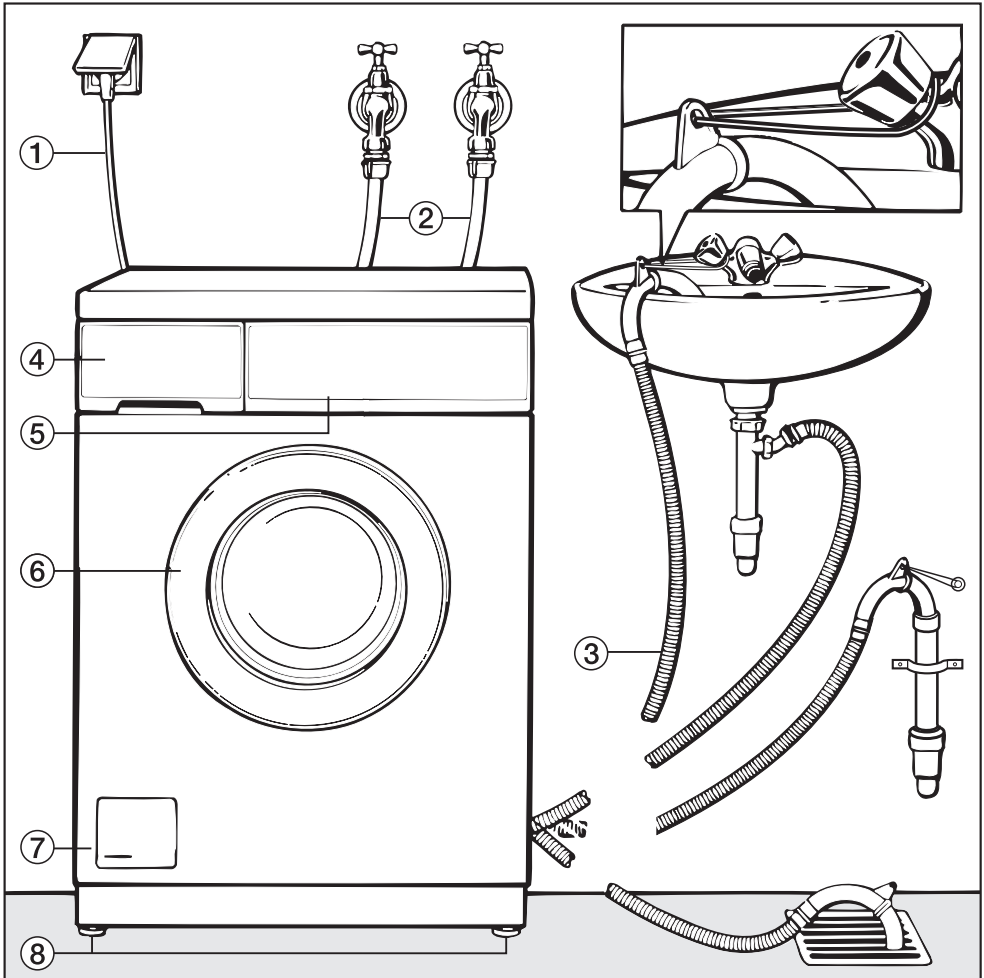

- ① Power cord
- ② High pressure intake hoses;  
blue mark for cold water,  
red mark for hot water
- ③ Flexible drain hose with detachable  
swivel elbow (drain options shown)
- ④ Detergent dispenser drawer
- ⑤ Control panel
- ⑥ Drum door
- ⑦ Access panel to lint trap and drain  
pump
- ⑧ Four height-adjustable feet

# Installation

---

## Installation site

Horizontal access washers should be installed on the ground floor or basement level of a construction for best performance.

A concrete or reinforced floor is the most suitable surface for the washer. These types of floors are less prone to vibration during the spin cycle.

If the installation must be performed on a wooden floor:

- Install the washer in the corner of a room, where the stability of the floor is greatest.
- The machine must be levelled and securely positioned.

To avoid vibration while spinning, the machine should not be installed on soft floor coverings.

- Install the unit on a 1 1/4" thick, 23 5/8" x 26 5/8" wide plywood base. Ideally, the base should be large enough to span several joists, and should be anchored to the joists, not just to the floor boards.

 If the machine is installed on a raised platform, it must be secured with retaining clips available from your dealer or the Miele Technical Service Department.

If installed on a masonry or concrete base, the base should have a 1/2" to 3/4" high rim. This will prevent the washer from vibrating off the stand during the spin cycle.



## Installation beneath a counter

If a countertop is placed over the washer, at least a  $\frac{1}{4}$ " gap must be left between the top of the machine and bottom of the countertop; nothing should be within  $\frac{1}{2}$ " of any other side of the washing machine.

## Washer / Dryer Stack

The Miele washing machine can be installed as part of a washer/dryer stack in combination with a Miele tumble dryer. The dryer can only be stacked on top of the washer and never vice versa.

The stacking kit, part # 12 996 026, is available from the Miele Technical Service Department or your Miele dealer.

**A washer and dryer should never be stacked without using the proper stacking kit. Doing so is extremely dangerous, as the dryer may vibrate off of the washing machine during use.**

# Installation

---

## Installation

- Lift the machine from its shipping pallet and move it to the installation site.
- Do not lift the washer by the drum door.
- Ensure that the machine's feet and the floor are dry to prevent slippage during the spin cycle.

## Remove the shipping struts

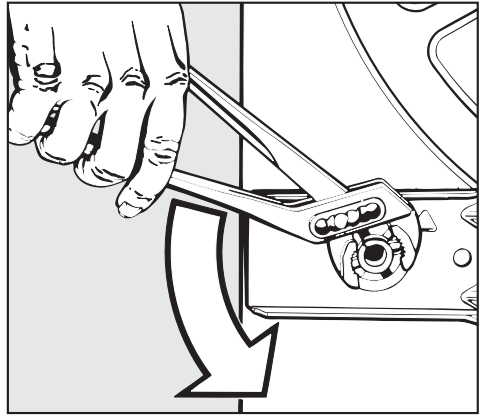

- Turn the left shipping strut counterclockwise 90°.

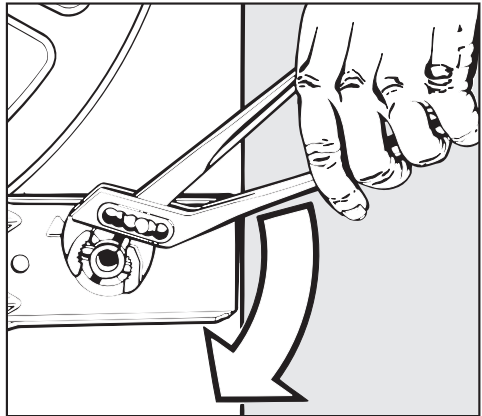

- Turn the right shipping strut clockwise 90°.

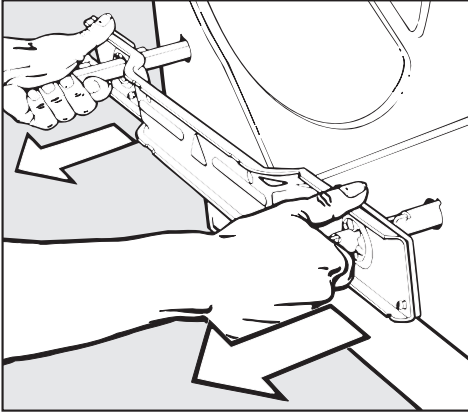

- Remove the two struts together with the support plate.

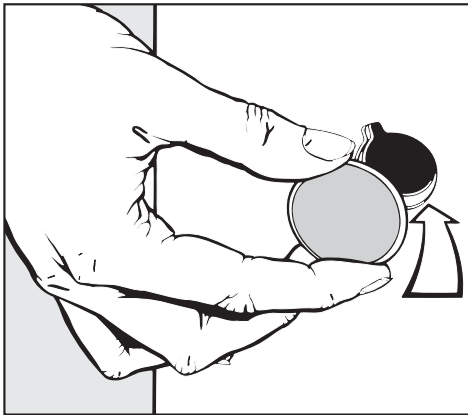

- Plug the two holes with the plastic caps provided.

 Movement of the washer without the shipping struts in place should be kept to a minimum. The struts must be reinstalled before the machine is moved. The shipping struts should be stored in a safe place for future use.

- Reinstall the struts by reversing the above procedure.

# Installation

## Level the washer

To ensure smooth operation, the washer must be level.

Failure to level the machine can result in increased water and energy consumption, loud noise during the spin cycle or "walking" across the floor during use.

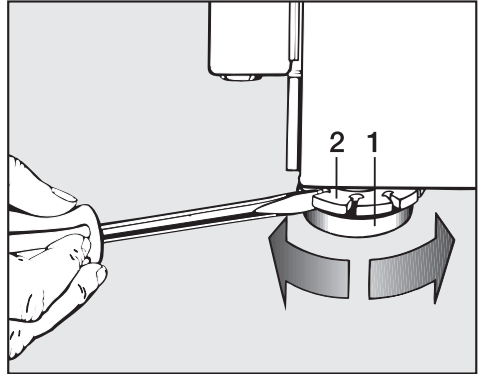
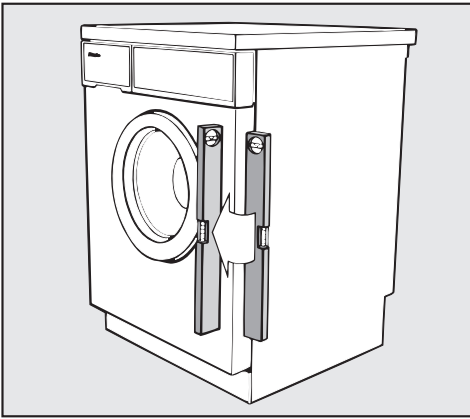

## Adjust the four leveling feet

The washer is leveled by adjusting the four feet:

- Tip the machine slightly and place a support, such as a block of wood, underneath it.

**⚠ CAUTION:** The washer is extremely heavy. When tipping the machine, be careful that it does not slip.

- Unscrew each of the four feet as much as necessary by turning both the foot, **1**, as well as the locking ring, **2**, to the left using a screwdriver.
- Remove the support and stand the machine on its feet.
- Check that the machine stands level.
- Repeat the above procedure until the machine stands level.
- Once level, hold the foot, **1**, immobile with a wrench. At the same time, turn the locking ring, **2**, to the right using a screwdriver.

**⚠** All four locking rings must be tight against the bottom of the machine. In addition, check to see that the feet were not inadvertently unscrewed while tightening the rings. Operating a machine that is not level or whose feet are not tight may cause damage to both the machine and its surroundings.

## Water connection

Connect the cold water intake hose (blue mark) to the cold water valve and the hot water intake hose (red mark) to the hot water valve.

If the machine is being connected to a cold water supply **only**, both the hot and cold water intake hoses must be attached to the cold water valve through the use of a Y adapter (available at a hardware store). Both hoses **must** be connected to a water source, or the machine will not function properly. **Do not** connect the washer to hot water only.

Turn on the valve(s) and check for leaks. The water pressure must be within 15-145 psi (1-10 bar). If the water pressure is greater than 145 psi (10 bar), a pressure reducer must be installed. If the water pressure is below 15 psi (1 bar), there will not be enough water available for a complete fill.

The water intake hoses are equipped with screen filters. Do not remove these filters except for cleaning.

## Tips for a hot water connection

- The hot water temperature from the hot water valve must not exceed 140°F; the ideal temperature is 130°F.
- If there is **no** water pressure at the hot water inlet, the unit automatically switches to cold water after several minutes.

## Plumbing connection

---

The washing machine can be connected to a potable water supply. A non-return valve is not required, unless required by building code.

The washing machine has  $\frac{1}{2}$ " pressure hoses with  $\frac{3}{4}$ " female hose thread connections. If there is no water hookup, contact a plumber to install a connection. Make sure that the sealing ring is seated properly on the hose connector.

Only replace the hose with a genuine Miele hose or with a hose able to withstand up to 145 psi (10 bar) pressure. The water valve connector must also be able to withstand 145 psi (10 bar).

To protect the inlet valve, the two filters - one at the pressure hose / valve connection and one at the inlet connection to the solenoid valve - must be in place during use.

## Drainage

The 5 foot drain hose may be connected as follows:

- 1. Directly into a sink:** hook the hose over the edge of the sink and secure it firmly (e.g. by tying the hose to the water faucet).
- 2. To a stand pipe:** place the drain hose into a 1 1/2" stand pipe and secure it firmly.
- 3. To a floor drain:** The machine is equipped with an airgap/anti-siphoning system so that no minimum drain height is required.

- The machine drains using a pump with a maximum delivery height of 4 feet.
- Make sure there are no kinks in the drain hose.

If desired, the drain hose may be extended to run a maximum of 16 feet, as long as the 4 feet height is not exceeded. Hose extensions are available from your dealer or Miele's Technical Service Department.

## Electrical connection

### GROUNDING INSTRUCTIONS

This appliance must be grounded. In the event of malfunction or breakdown, grounding will reduce the risk of electric shock by providing a path of least resistance for electric current. This appliance is equipped with a cord having an equipment-grounding conductor and a grounding plug. The plug must be plugged into an appropriate outlet that is properly installed and grounded in accordance with all local codes and ordinances.

**WARNING** – Improper connection of the equipment-grounding conductor can result in a risk of electric shock. Check with a qualified electrician or service representative if you are in doubt as to whether the appliance is properly grounded.

Do not modify the plug provided with the appliance; if it will not fit the outlet, have a proper outlet installed by a qualified electrician.

### ELECTRICAL INSTRUCTIONS

This installation should be performed by an experienced and qualified technician, in accordance with local codes and regulations.

The washing machine is supplied with a 5' 3" long, 4 wire cord, ending in a NEMA 14-30 P plug, ready for connection to a 120/208-240 V, 15 A, 60 Hz, AC power supply.

The proper outlet can be purchased from an electrical supply dealer or from the Miele Technical Service Department (request a NEMA 14-30 R receptacle).

### "EASY INSTALLATION KIT"

If a dedicated 4 wire, 120/208-240 V, 15 Amp line is not available for this appliance, an optional "Easy Installation Kit" will allow you to connect to a 240 V, 30 Amp line .

This dual receptacle, wall mounted connection box can **ONLY** be used for connecting a Miele 1900 series clothes washer and 1500 series clothes dryer to an existing 30 Amp (NEMA 10-30R) outlet.

For more information on the "Easy Installation Kit," or if you have questions concerning the electrical connection, please contact:

**(USA)** 1-800-999-1360  
techserv@mieleusa.com

**(CDN/F)** 1-800-565-6435  
service@miele.ca









**When contacting the Technical Service,  
please quote the model and serial number  
of your appliance.**

---

The Miele logo consists of the word "Miele" in a bold, white, serif font, set against a solid black rectangular background.

**Miele, Inc.** (USA)

**National Headquarters**

9 Independence Way  
Princeton, NJ 08540  
Phone: 800-843-7231  
609-419-9898  
Fax: 609-419-4298  
www.mieleusa.com

**Technical Service & Support**

**Nationwide**

Phone: 800-999-1360  
Fax: 888-586-8056

**Miele Limited** (CDN)

**National Headquarters**

55G East Beaver Creek Road  
Richmond Hill, ON L4B 1E5  
Phone: 800-643-5381  
905-707-1171  
Fax: 905-707-0177  
www.miele.ca  
info@miele.ca (general enquiries)  
professional@miele.ca (commercial  
enquiries)

**Mielecare National Service**

Phone: 800-565-6435  
905-850-7456  
Fax: 905-850-6651  
service@miele.ca (Tech. Service)